

TRINNOV
AUDIO

NOVA

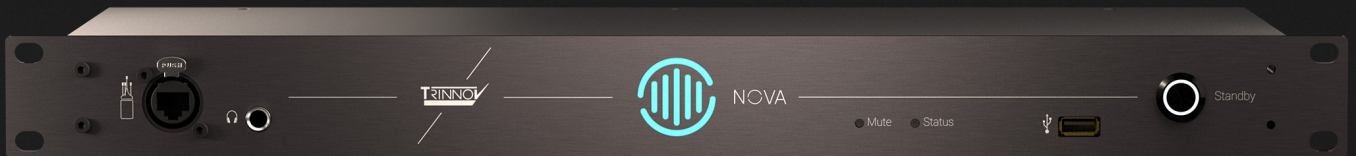

A Star is (re)born

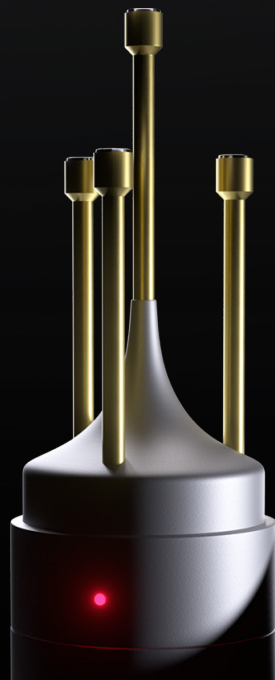

www.trinnov.com



NOVA

THE NEW STUDIO ESSENTIAL

NOVA is set to become the new must-have in the music industry. Compact, powerful and flexible, it will fit in your studio or in your backpack and turn out to be the most essential piece of equipment you've ever purchased.

Our Optimizer technology is arguably the most efficient supercharger for your mixes. With its softer price tag, NOVA makes this essential technology more accessible to music makers.

Yet, NOVA is not just an Optimizer, it is the backbone of your entire monitoring system.

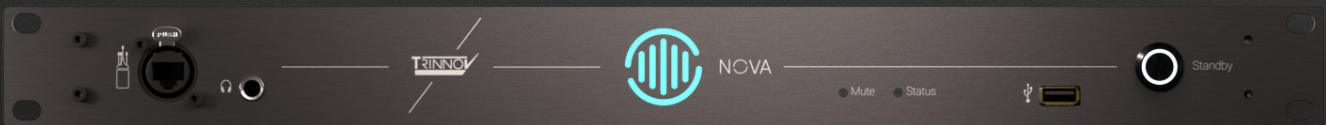



WORK BETTER AND FASTER WITH TRINNOV'S OPTIMIZER

WHAT'S MORE CRUCIAL THAN A RELIABLE MONITORING SYSTEM?

From renowned sound engineers to loudspeaker manufacturers, Loudspeaker/Room Optimization is being fast adopted by the music industry.

This area of acoustic research and innovation has been our main focus and expertise since 2005. We are recognized as the undisputed leader in this field.

NOVA gives you access to our cutting-edge Trinnov Optimizer technology.

Change the way you work and never look back. Stop second-guessing and start focusing on music.

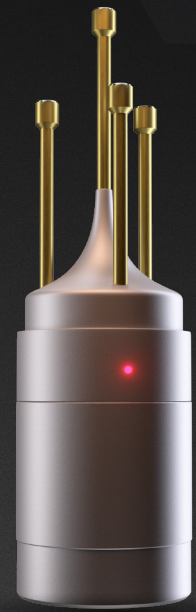

HEAR IT FROM THEM, NOT FROM US



"A tool that allows you to get the job done without anything obscuring your vision. It takes the room out of the equation. For me, this is the way to get world-class results almost anywhere."

Pete Lyman - Mastering Engineer

"Trinnov has given me the truest and most precise sound to come out of my studio, and allows me to get the perfect mix downs with confidence, every time. In my opinion, this really is the box of dreams."

Roni Size - Drum & Bass Royalty

"I challenge any sound engineer or music producer not to be completely amazed by how it sounds and by what it can do! By taking the guesswork out of your mixes, the ST2 Pro makes the decision process much quicker."

Leftfield - Electronic Music Legend

"Not only the amplitude but the phase correction, I mean to be honest I thought it was witchcraft! It was like this is how it should be sounding anyway."

Lovy Longomba - Music Producer



THE ESSENTIAL MONITORING TOOLBOX

Packed in a shallow 1U chassis, NOVA is deceptively powerful and covers all your monitoring needs from stereo to 5.1.

COMPREHENSIVE MONITOR CONTROLLER

NOVA handles analog and digital signals like no other monitor controller. Connect, align, and seamlessly switch between sources and multiple sets of monitors, regardless of their format or connection. You can also create your own downmix profiles to check the phase and mono compatibility of your mixes.

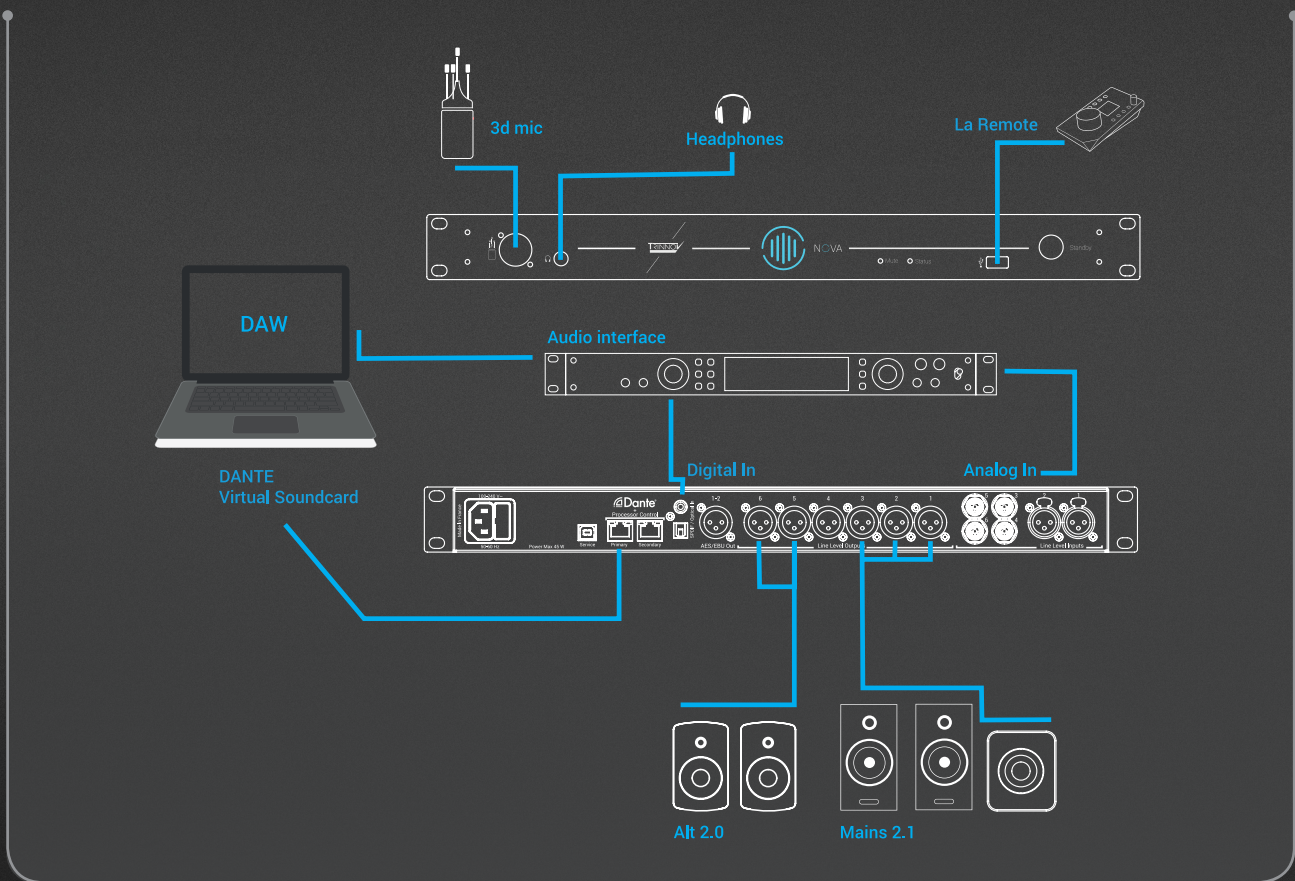

HIGH QUALITY I/Os

NOVA comes with a comprehensive set of I/Os to connect all your equipment in analog, digital, or even Dante Audio-over-IP. Trinnov's latest DAC and ADC deliver crisp signals to your monitors and drive the integrated headphone output.

DANTE AUDIO INTERFACE

As a Dante device, connect NOVA easily within your audio network with low latency (down to 250 microseconds). You can also use NOVA as your main audio interface along with the Dante virtual sound card for direct DAW-to-monitoring integration.

LOUDSPEAKER/ROOM OPTIMIZER

Enjoy Trinnov's acclaimed Optimizer technology across all your loudspeakers. Rediscover your monitoring system and a new, far more enjoyable and efficient music making experience. The backlit NOVA logo on the front panel indicates the Optimizer and calibration status.

EASY INTEGRATION

Being Avid EUCON compliant, NOVA allows advanced monitoring control and can easily be integrated to your production tools. It can be set up either as a full monitoring controller on multiple speaker sets with sources selection and summation or as a discreet embedded audio insert processing toolbox in the loudspeaker path.

LA REMOTE

Use NOVA with our dedicated hardware controller "La Remote". Take control of every function of NOVA at the press of a button. Through an easy drag n drop web interface, personalize "La Remote" to your workflow. and adjust the functions and labels of its seven buttons to suit your environment!

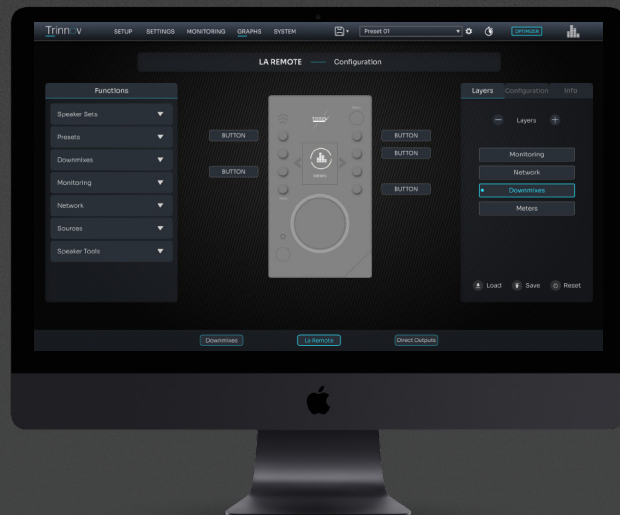

BASS MANAGEMENT

Subwoofers integration is a common challenge in studios. Yet, integrating subwoofers seamlessly still brings multiple benefits to all mixers and sound designers. NOVA handles this daunting task easily either over single or dual subwoofer configurations and let you even share the same subwoofers across multiple monitor sets in an instant.

UPGRADEABLE FROM 2 TO 6 CHANNELS

NOVA is also evolutive, allowing you to upgrade from 2 to 6 channels with a license system. In order to proceed to the upgrade, just get in touch with your local distributor, which will provide the additional license through a simple software update.



TRINNOV'S NEW HARDWARE GENERATION

NOVA is the first of a new generation of Trinnov products, based on an entirely redesigned platform which redefines the way Trinnov designs audio processors.

After more than 4 years of development, our new hardware platform combines greater modularity, higher performance, enhanced reliability and native support for Audio-over-IP.

This new hardware was also designed with the user experience in mind, enabling for more streamlined setup and day to day operations.

NEW HARDWARE ARCHITECTURE

Our new hardware architecture provides more modularity and possibilities in terms of product development, starting with the ability to make PC-less and fan-less products, such as NOVA !!

This new architecture also allows us to design products around single electronic boards for optimum efficiency, reliability, and transportability.

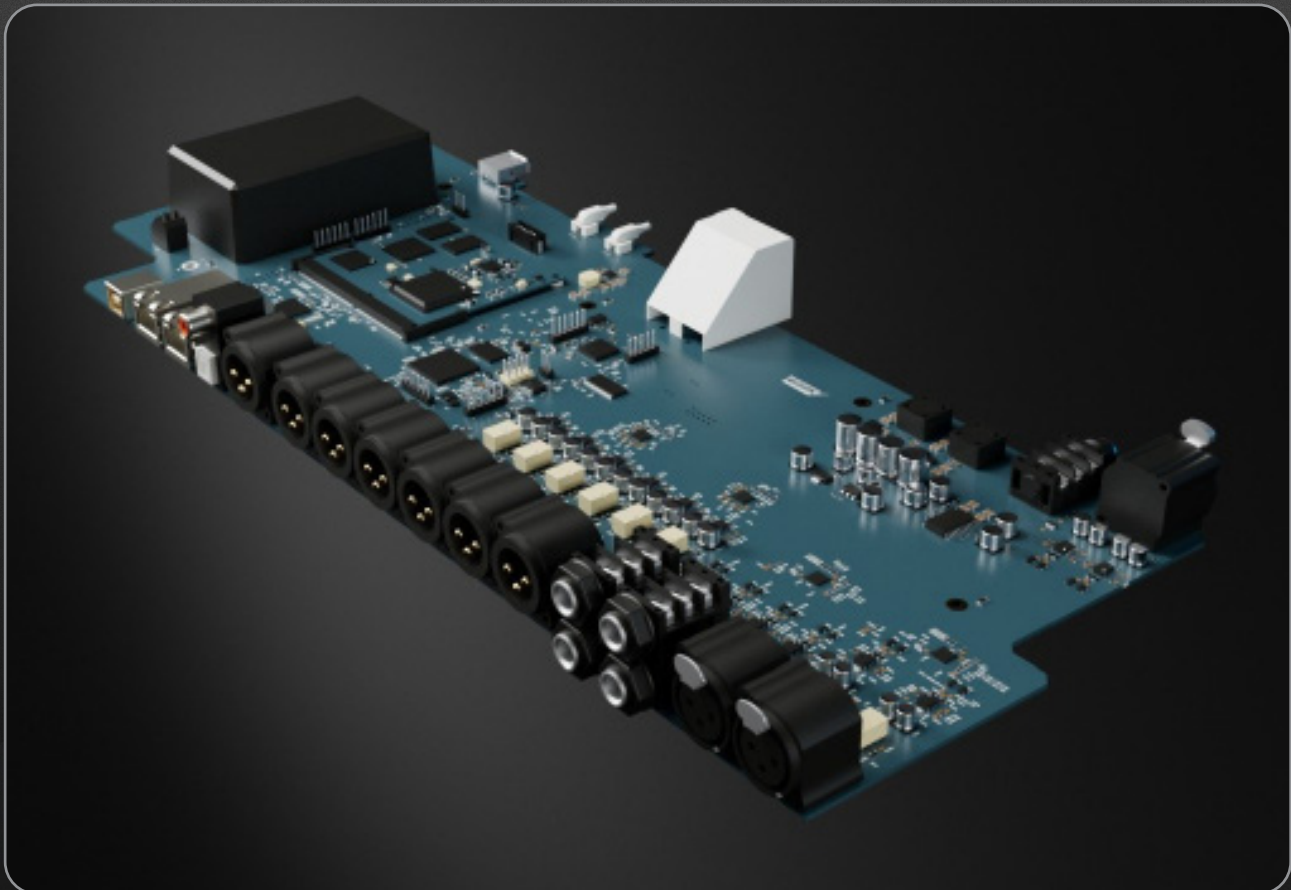

NEW AUDIO CORE

One of the most critical developments was the redesign of the Trinnov Audio Core, the main audio component of our products. The TAC2 is five times smaller than the previous one, and yet comes with added features and better performances.

NEW AD/DA SECTION

The AD/DA section has also been redesigned around ESS Sabre chipsets. Noise and distortion levels have been reduced at all frequencies, allowing for more accurate monitoring.

NEW OPERATING SYSTEM

Still custom Linux based, we entirely re-engineered the operating system which optimizes hardware performance, security, upgradability and network management. This operating system drives our new audio core, which is more compact, efficient and handles the audio processing thanks to its built-in ARM processor.

NEW 3D MICROPHONE

We improved the measurement microphone with your needs in mind for better simplicity and reliability. It is now equipped with phantom power (no more batteries required) and integrated memory. This enables a more streamline calibration process, removing the need to manually import the microphone compensation file.

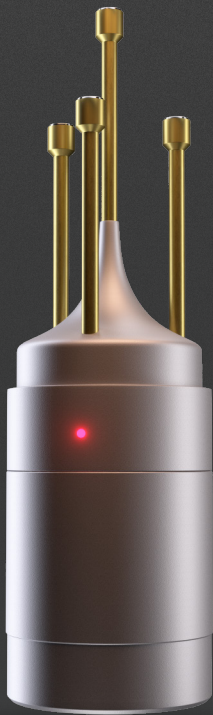

It connects to its dedicated etherCON connector, and can be used with any CAT6 network cable.

EASY SETUP AND USE

The Optimizer technology is very sophisticated but we made it simple to use thanks to a completely redesigned user experience.

START WITH THE **TRINNOV APP**

- Download the Windows or macOS Trinnov application.
- Start the app and automatically find your Trinnov Audio processor on the local network.
- Take control of your processor's main features, volume, dim, mute, preset selection.

THE NEW TRINNOV IOS APP

Take control of your Trinnov processor from your local network and use your iOS device as a remote control.

Control your Trinnov Processor from your iOS Device.



From the Trinnov app, you can also open a simple control window rather than the full user interface. The simplified control App is similar to the iPad and iPhone version of the Trinnov App.

From controlling the volume to mute and dim, the app will also let you change sources or trigger your favorite presets to name a few options.

NEW GRAPHICAL USER INTERFACE

For NOVA, we redesigned the user interface completely around a modern web-based interface. With its built-in help and clear menu structure, using NOVA should be self-explanatory, including the Setup procedure for which you will be guided through a simple step by step sequence.

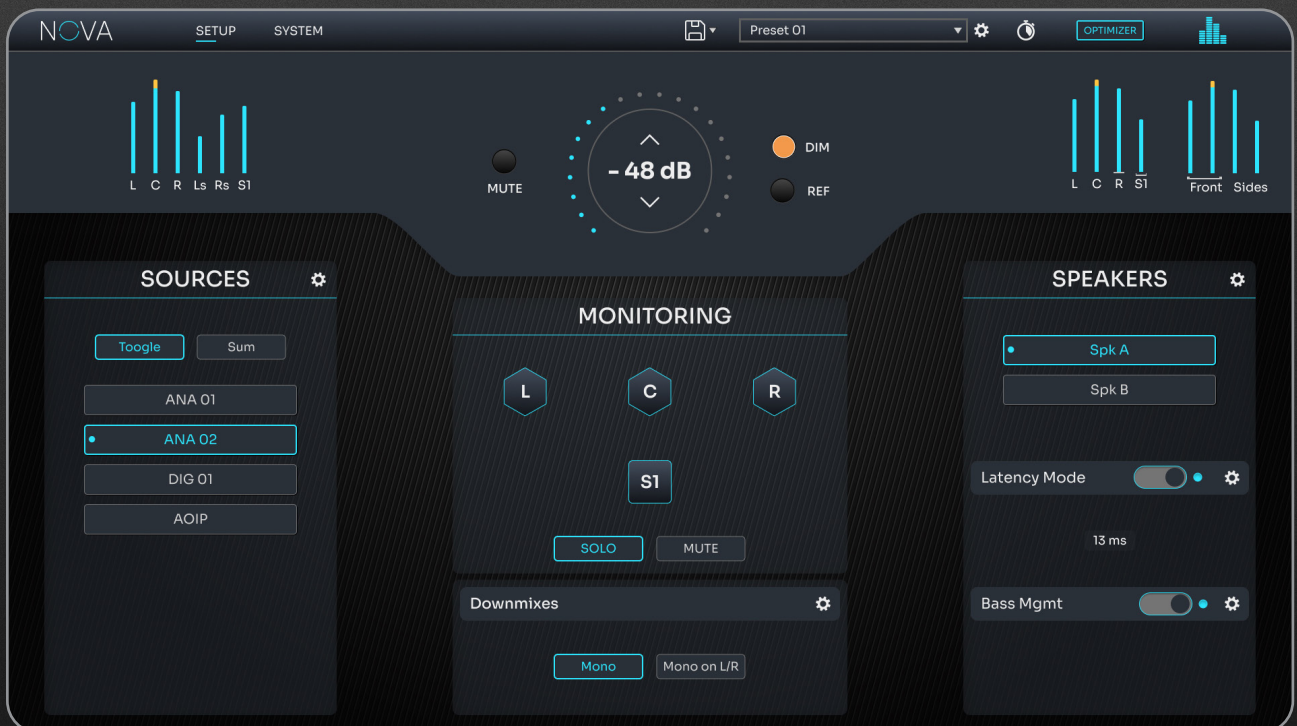



SPECIFICATIONS

FRONT PANEL

- 1x Calibration Microphone Ethercon Input
- 1x Jack 6.35 stereo Headphone Output
- 1x USB Type A port for La Remote
- Standby / Mute button
- LED status

AUDIO & PROCESSING

- ADC Resolution / Sampling Rate :
24 Bits/192 kHz
- DAC Resolution / Sampling Rate :
24 Bits/192 kHz
- A/D Dynamic Range (AES17) :
115 dB (A-Weighted, ref. +18dBu)
- D/A Dynamic Range (AES17) :
115 dB (A-Weighted, ref. +18dBu)
- D/A THD+N ratio : > 110dB,
1kHz@0dBFS (20kHz BW)
- Processing Sampling Rate : Native
(no internal sampling rate conversion)
- Processing Resolution :
64 bits floating point
- 2 Optimizer processing channels included
(upgradable)

REAR PANEL

Digital

- 1x ADAT or SPDIF optical input
- 1x SPDIF coaxial input
- 2x Ethernet ports (Dante 8in/8out)
- 1x AES3 XLR stereo output

Analog

- 2x XLR Balanced Inputs
- 4x Jack 6.35 Balanced Inputs
- 6x XLR Balanced Outputs

POWER SUPPLY

- Power requirement : 90-127v/220-230v
AC 50Hz/60Hz
- Power consumption : 15W
- Mains fuse : T400mA slow blow
- Integrated (no external transformer,
standard IEC socket)
- Fanless design for silent operation

NETWORK

- Network connectivity : IPV4
dual connector with configurable
integrated switch
- IP Configuration modes : DHCP / Auto-IP
link local / fixed IP
- Eucon compatibility via the "Trinnov App"

WEIGHT & DIMENSIONS

- Dimensions (W x H x D) mm : 482 x 44 x 192
- Dimensions (W x H x D) inches : 19" x 1.7" x 7.3"
- Shipping box dimensions (W x H x D) cm : 59 x 9 x 31
- Weight : 2.5 kg / 5.5 lbs
- Shipping weight / volume : 4 kg / 0.02 m³
- Rack Mounting : 1U - Fixed Rack Ears

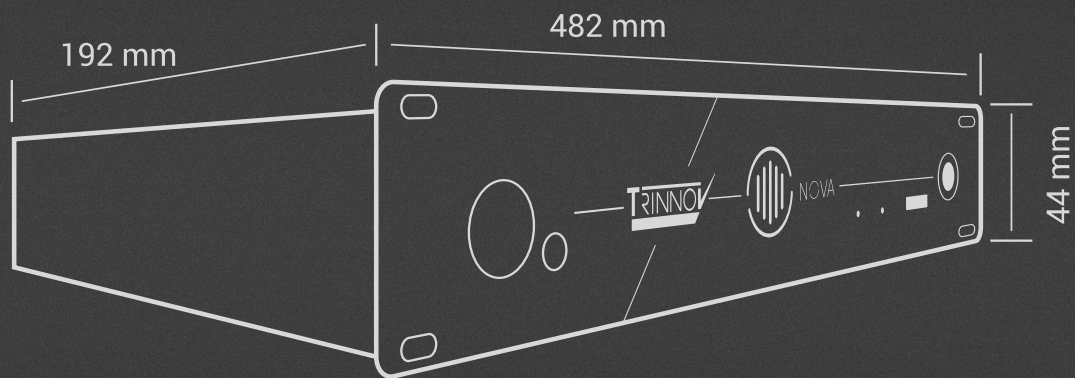

OPTIONS

- 2-channel software bundle to upgrade NOVA up to 6 processing channels
- 3D Measurement Microphone
- La Remote : USB-Remote monitoring controller : directly connected to the NOVA or to your DAW

WARRANTY

- Standard Warranty : 2 years
- Transferable : Yes

NOVA

www.trinnov.com

contact : pro@trinnov.com

